

PROPRIETARY RIGHTS ARE CLAIMED FOR THE MATERIAL DISCLOSED IN THIS DRAWING.

POSITIVE TERMINAL

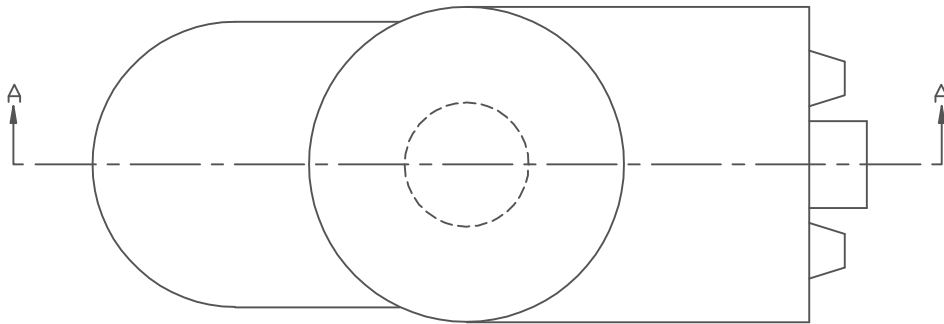

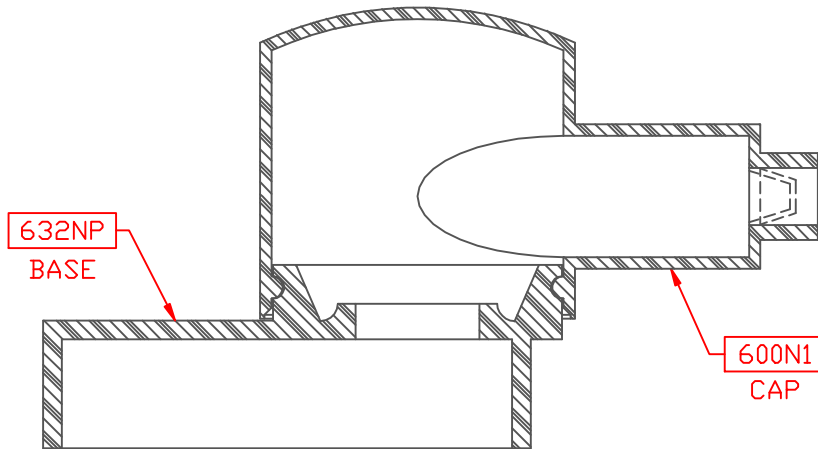

(1) 73014 KIT CONTAINS THE FOLLOWING

QUANTITY	PART #	DESCRIPTION
1	600N1V02	BATTERY TERMINAL CAP
1	632NPV02	BATTERY TERMINAL BASE

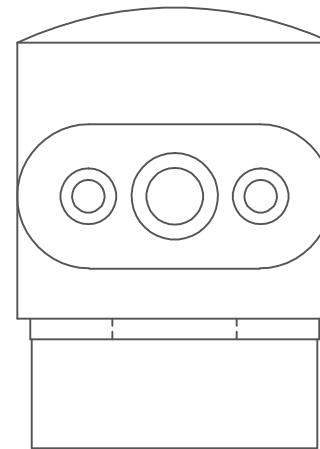

SECTION A-A



		VTE Incorporated 5437 Robinson Road, P.O. Box 790 Pellston, Michigan 49769 Telephone: 1-800-527-9256, 231-539-8000 FAX: 231-539-0914	
		REF:	DATE: 5-4-98
TITLE: MARINE BATTERY TERMINAL BOOT ASSEMBLY			
MATERIAL:		PART NO. 73014	
COLOR:	DRG CLASS		