

PROPRIETARY RIGHTS ARE CLAIMED FOR THE MATERIAL DISCLOSED IN THIS DRAWING.

POSITIVE TERMINAL

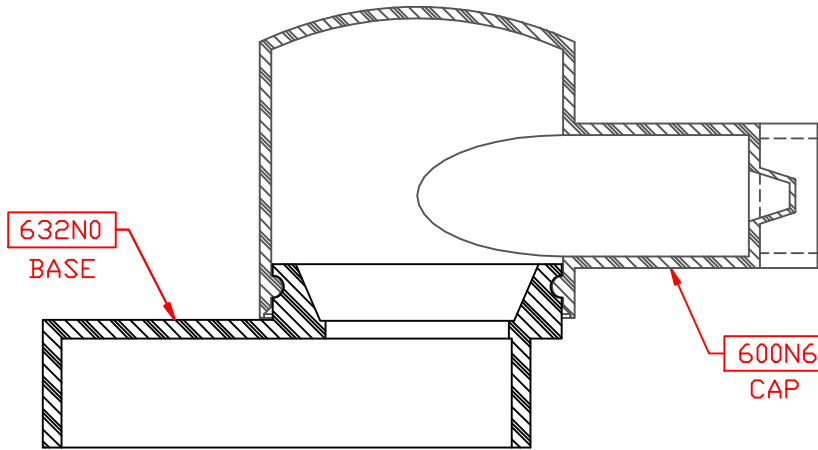
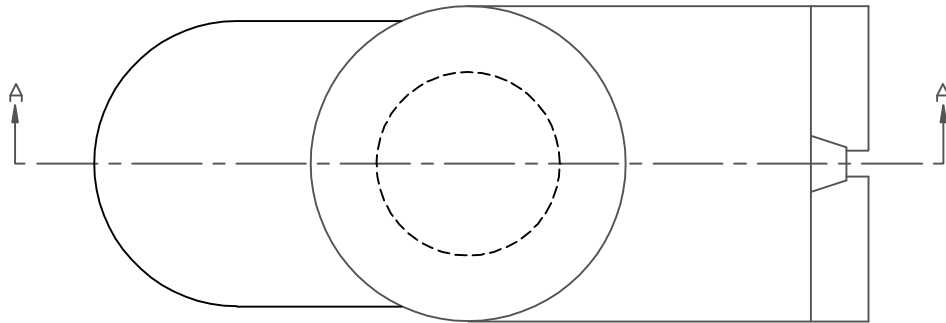

SECTION A-A

(1) 75064 KIT CONTAINS THE FOLLOWING

QUANTITY	PART #	DESCRIPTION
1	600N6V02	BATTERY TERMINAL CAP
1	632N0V02	BATTERY TERMINAL BASE

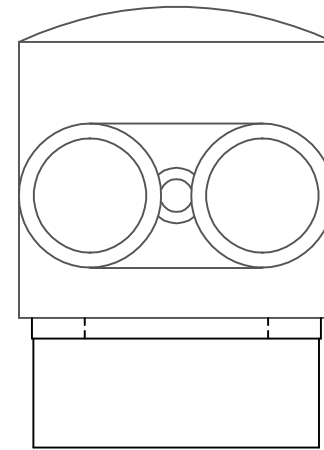

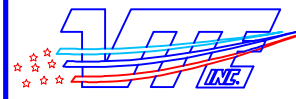
		VTE Incorporated 5437 Robinson Road, P.O. Box 790 Pellston, Michigan 49769 Telephone: 1-800-527-9256, 231-539-8000 FAX: 231-539-0914	
REF:	DATE: 5-4-98	DRN BY: JC	WEIGHT: ****
TITLE: MARINE BATTERY TERMINAL BOOT ASSEMBLY		CHK'D BY:	
MATERIAL:		PART NO. 75064	
COLDR:	DRG CLASS		