

THE INFORMATION CONTAINED IN THIS DRAWING IS THE SOLE PROPERTY OF VTE INCORPORATED. ANY REPRODUCTION IN PART OR WHOLE WITHOUT THE WRITTEN PERMISSION OF VTE INCORPORATED IS PROHIBITED. VTE MAKES NO WARRANTY, EXPRESSED OR IMPLIED, AS TO THE SUITABILITY OF A PRODUCT FOR ANY INTENDED USE. THE CUSTOMER SHALL BEAR THE SOLE RESPONSIBILITY OF DETERMINING THE SUITABILITY OF ANY VTE PRODUCT FOR ITS END USE.

LTR.	REVISIONS	DATE	INT.
△	ADDED REFERENCE DIMENSION	02-25-16	RAS

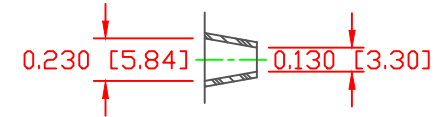
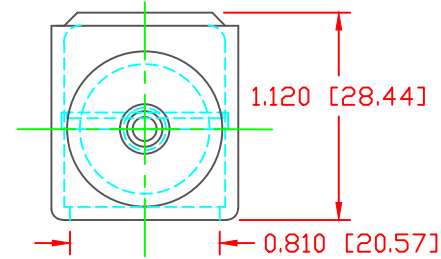
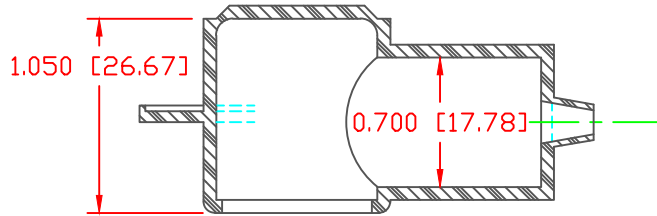

SECTION A-A  
TYP. WALL THICKNESS = .070" [1.8]  
SEAL NO. 1 SHOWN

SEAL THICKNESS = .030" [.8]  
NO. 1  
Wire Gages  
18 - 10

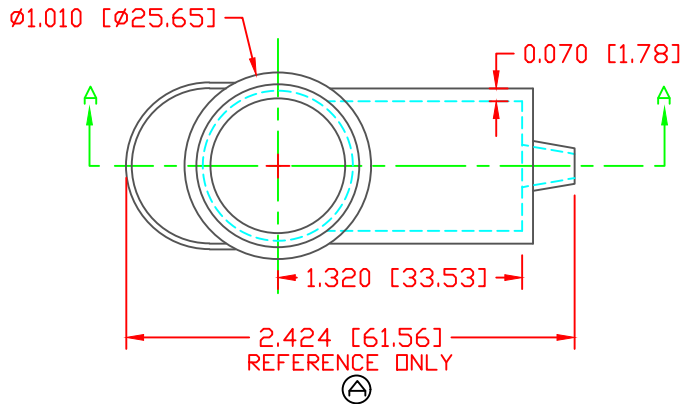

SCALE FACTOR : NONE  
ALL DIMENSIONS GIVEN AS: in [mm]  
TOLERANCES UNLESS OTHERWISE SPECIFIED :  
MOLDED PARTS: ±.030" [±0.8mm]  
ALL ANGLES ARE ± 1 DEGREE

MATERIAL PART NO:	1101650114
MATERIAL:	PVC
VENDOR PART NO:	9812-65-BLACK
SHORE DUROMETER:	"A" 10 SEC. 65
SPECIFIC GRAVITY:	1.34
ULT. ELONGATION %:	400
MELTING TEMP:	315-335 F [157-168 C]
BRITTLE TEMP:	-54 F [-48 C]
Tensile Strength PSI:	1550 PSI
Dielectric Strength, v./mil	453
U.L. Rating:	V2

DO NOT SCALE

		<b>VTE Incorporated</b> 5437 Robinson Road, P.O. Box 790 Pellston, Michigan 49769 Telephone: 1-800-527-9256, 231-539-8000 FAX: 231-539-0914	
		REF:	DATE:
CUSTOMER DIMS	03-24-98	CHK'D BY: JC	.022 LBS [9.75 g]
TITLE: TERMINAL INSULATOR CAP			
MATERIAL: PVC		PART NO.	
COLOR: BLACK		222N1V14	
DRG CLASS REV A			