

THE INFORMATION CONTAINED IN THIS DRAWING IS THE SOLE PROPERTY OF VTE INCORPORATED. ANY REPRODUCTION IN PART OR WHOLE WITHOUT THE WRITTEN PERMISSION OF VTE INCORPORATED IS PROHIBITED. VTE MAKES NO WARRANTY, EXPRESSED OR IMPLIED, AS TO THE SUITABILITY OF A PRODUCT FOR ANY INTENDED USE. THE CUSTOMER SHALL BEAR THE SOLE RESPONSIBILITY OF DETERMINING THE SUITABILITY OF ANY VTE PRODUCT FOR ITS END USE.

LTR.	REVISIONS	DATE	INT.
△	ADDED REFERENCE DIMENSION	02-25-16	RAS

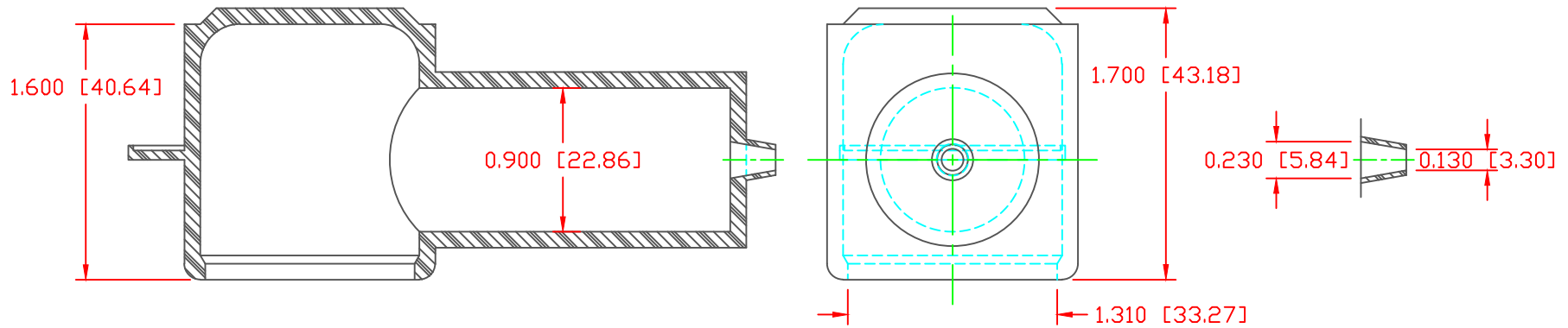

SECTION A-A
 TYP. WALL THICKNESS = .100" [2.5]
 SEAL NO. 1 SHOWN

SEAL THICKNESS = .030" [.8]
 NO. 1
 Wire Gages
 18 - 10

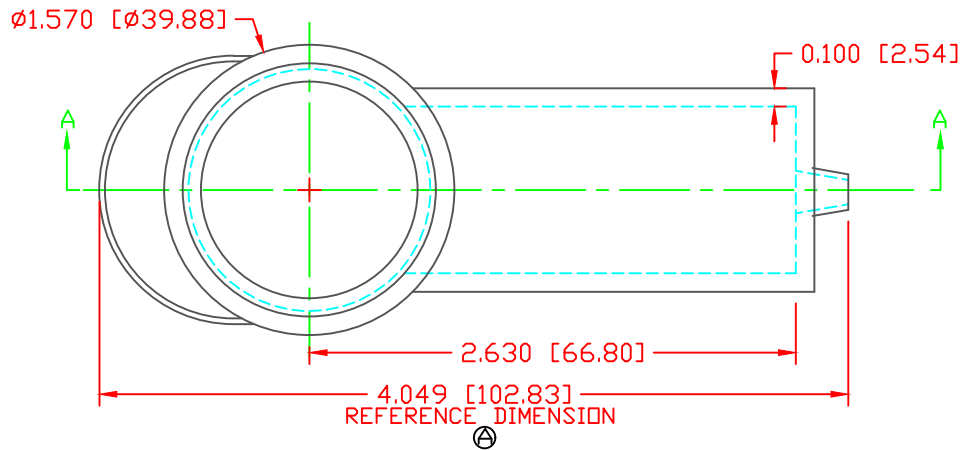

ALL DIMENSIONS GIVEN AS: in [mm]
 MOLDED PARTS: ±.030" [±0.8mm]
 HARDWARE ITEMS: ±.010" [±0.25mm]

VTE PART NO:	1101700114
MATERIAL:	PVC
VENDOR PART NO:	7843-70-BLACK
SHORE DUROMETER:	"A" 10 SEC. 70
SPECIFIC GRAVITY:	1.34
ULT. ELONGATION %:	350
MELTING TEMP:	320-340 F [160-171 C]
BRITTLE TEMP:	-22 F [-30 C]
Tensile Strength PSI:	1500 PSI
Dielectric Strength, v./mil	500
U.L. Rating:	V0

DO NOT SCALE

		VTE Incorporated 5437 Robinson Road, P.O. Box 790 Pellston, Michigan 49769 Telephone: 1-800-527-9256, 231-539-8000 FAX: 231-539-0914	
		REF:	DATE:
CUSTOMER DIMS	03-25-98	CHK'D BY: JC	.078 LBS [35.3 g]
TITLE: TERMINAL INSULATOR CAP			
MATERIAL: PVC		PART NO.	
COLOR: BLACK	DRG CLASS REV A	234E1F14	