

THE INFORMATION CONTAINED IN THIS DRAWING IS THE SOLE PROPERTY OF VTE INCORPORATED. ANY REPRODUCTION IN PART OR WHOLE WITHOUT THE WRITTEN PERMISSION OF VTE INCORPORATED IS PROHIBITED. VTE MAKES NO WARRANTY, EXPRESSED OR IMPLIED, AS TO THE SUITABILITY OF A PRODUCT FOR ANY INTENDED USE. THE CUSTOMER SHALL BEAR THE SOLE RESPONSIBILITY OF DETERMINING THE SUITABILITY OF ANY VTE PRODUCT FOR ITS END USE.

LTR.	REVISIONS	DATE	INT.

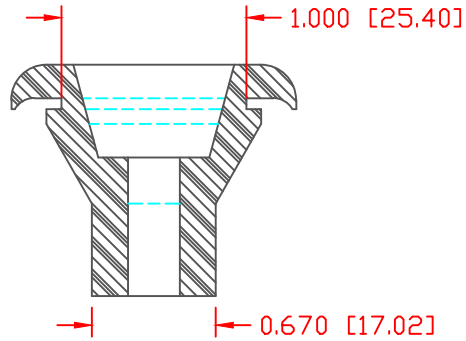
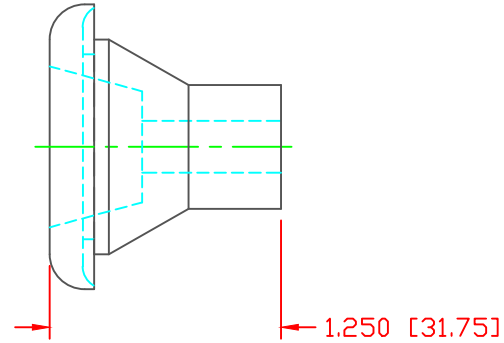
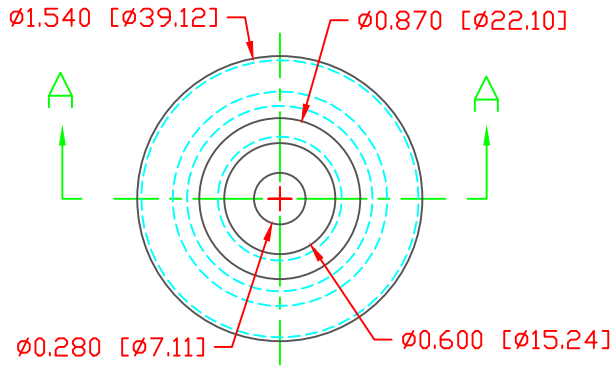

SECTION A-A

SCALE FACTOR : NONE
 ALL DIMENSIONS GIVEN AS: in [mm]
 TOLERANCES UNLESS OTHERWISE SPECIFIED :
 MOLDED PARTS: ±.030" [±0.8mm]
 ALL ANGLES ARE ± 1 DEGREE

VTE PART NO:	1101650114
MATERIAL:	PVC
VENDOR PART NO:	9812-65-BLACK
SHORE DUROMETER:	"A" 10 SEC. 65
SPECIFIC GRAVITY:	1.34
ULT. ELONGATION %:	400
MELTING TEMP:	315-335 F [157-168 C]
BRITTLE TEMP:	-54 F [-48 C]
Tensile Strength PSI:	1550 PSI
Dielectric Strength, v./mil	453
U.L. Rating:	V2

DO NOT SCALE

		VTE Incorporated 5437 Robinson Road, P.O. Box 790 Pellston, Michigan 49769 Telephone: 1-800-527-9256, 231-539-8000 FAX: 231-539-0914	
		REF:	DATE:
CUSTOMER DIMS	03-25-98	CHK'D BY: JC	.030 LBS [13.4 g]
TITLE: GROMMET, WIRING 1" DIAMETER HOLE			
MATERIAL: PVC	PART NO.		310N6V14
COLOR: BLACK	DRG CLASS		