

THE INFORMATION CONTAINED IN THIS DRAWING IS THE SOLE PROPERTY OF VTE INCORPORATED. ANY REPRODUCTION IN PART OR WHOLE WITHOUT THE WRITTEN PERMISSION OF VTE INCORPORATED IS PROHIBITED. VTE MAKES NO WARRANTY, EXPRESSED OR IMPLIED, AS TO THE SUITABILITY OF A PRODUCT FOR ANY INTENDED USE. THE CUSTOMER SHALL BEAR THE SOLE RESPONSIBILITY OF DETERMINING THE SUITABILITY OF ANY VTE PRODUCT FOR ITS END USE.

LTR.	REVISIONS	DATE	INT.
A	.502" WAS .482", .572" WAS .558"	03-14-07	BRH
B	INTERNAL UPDATES	03-14-07	BRH
C	ADDED N5 (10MM) OPTION	07-09-08	BRH
D	REVISED DIMENSION FROM 0.453 [11.51]	2-06-18	RAS
E	REVISED MATERIAL INFORMATION	07-17-18	RAS

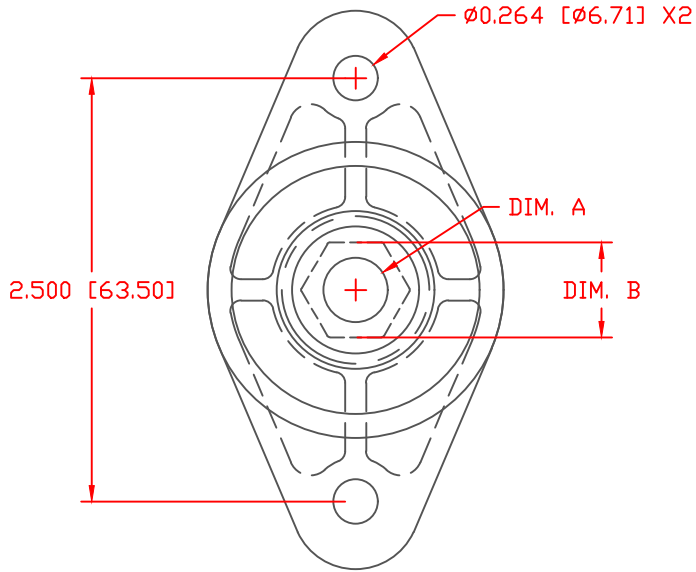

	*	DIM A	DIM B	DIM C	STUD SIZE
	2	.256"	.447"	.170"	1/4"
(A)	3	.318"	.502"	.228"	5/16"
(A)	4	.375"	.572"	.266"	3/8"
(C)	5	.395"	.665"	.295"	M-10

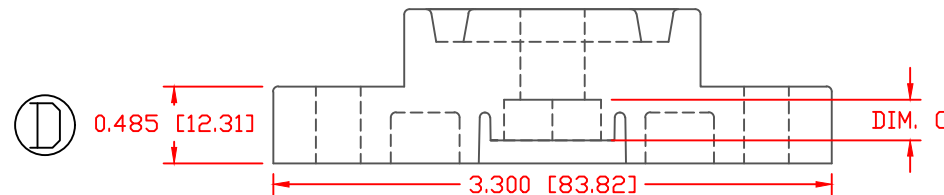
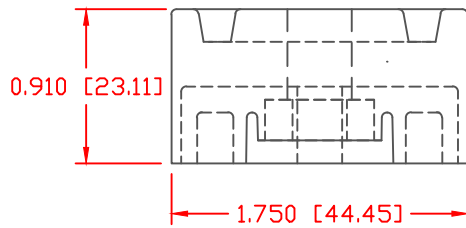

SCALE FACTOR : NONE
 ALL DIMENSIONS GIVEN AS: in [mm]
 TOLERANCES UNLESS OTHERWISE SPECIFIED :
 MOLDED PARTS: ± 0.030 [± 0.8 mm]
 HARDWARE ITEMS: ± 0.010 [± 0.25 mm]

MATERIAL PART NO:
 MATERIAL:
 VENDOR PART NO:
 SPECIFIC GRAVITY:
 MELTING TEMP:
 U.L. RATING:

7111210502
 GLASS FILLED NYLON
 NYLON N2015 HL NAT
 1.23
 515 F [268 C]
 UL 94 HB



VTE Incorporated
 5437 Robinson Road, P.O. Box 790
 Pellston, Michigan 49769
 Telephone: 1-800-527-9256, 231-539-8000
 FAX: 231-539-0914

REF:	DATE: 11-20-03	DRN BY: BRH	WEIGHT:
CUSTOMER DIMS		CHK'D BY: BRH	.0855 LBS [38.8 g]
TITLE: POST TYPE JUNCTION BLOCK			
MATERIAL: GLASS FILLED NYLON		PART NO.	
COLOR: RED		328N4N02	
DRG CLASS: REV E			

DO NOT SCALE