

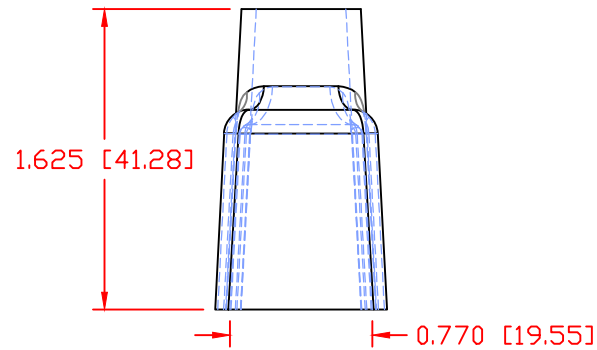

THE INFORMATION CONTAINED IN THIS DRAWING IS THE SOLE PROPERTY OF VTE INCORPORATED. ANY REPRODUCTION IN PART OR WHOLE WITHOUT THE WRITTEN PERMISSION OF VTE INCORPORATED IS PROHIBITED. VTE MAKES NO WARRANTY, EXPRESSED OR IMPLIED, AS TO THE SUITABILITY OF A PRODUCT FOR ANY INTENDED USE. THE CUSTOMER SHALL BEAR THE SOLE RESPONSIBILITY OF DETERMINING THE SUITABILITY OF ANY VTE PRODUCT FOR ITS END USE.

LTR.	REVISIONS	DATE	INT.
△	REDRAWN AND UPDATED ( ORIGINAL DRAWING 1-07-14 )	6-14-19	RAS

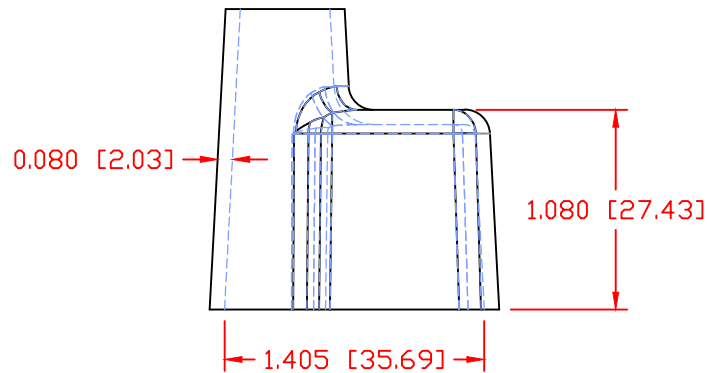
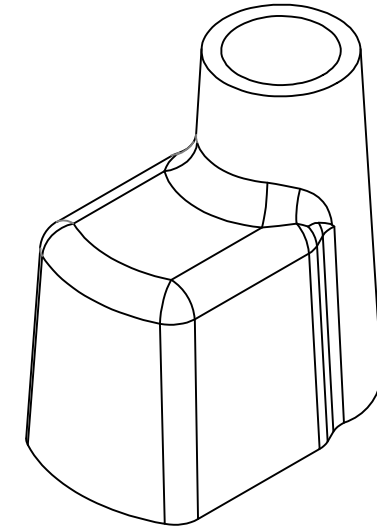
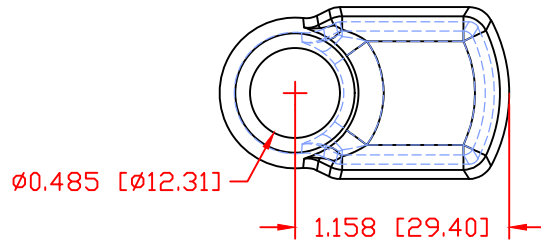

SCALE FACTOR : NONE  
 ALL DIMENSIONS GIVEN AS: in [mm]  
 TOLERANCES UNLESS OTHERWISE SPECIFIED :  
 MOLDED PARTS: ±.030" [±0.8mm]  
 ALL ANGLES ARE ± 1 DEGREE

MATERIAL PART NO:	1101650102
MATERIAL:	PVC
VENDOR PART NO:	9812-65-RED 683
SHORE DUREMETER:	"A" 10 SEC. 65
SPECIFIC GRAVITY:	1.34
ULT. ELONGATION %:	400
MELTING TEMP:	315-335 F [157-168 C]
BRITTLE TEMP:	-54 F [-48 C]
TENSILE STRENGTH PSI:	1550 PSI
DIELECTRIC STRENGTH, V./mil	511
U.L. RATING:	V2

		<b>VTE Incorporated</b> 5437 Robinson Road, P.O. Box 790 Pellston, Michigan 49769 Telephone: 1-800-527-9256, 231-539-8000 FAX: 231-539-0914	
		REF: CUSTOMER DIMS	DATE: 6-14-19
TITLE: BATTERY TERMINAL INSULATOR			
MATERIAL: PVC		PART NO.	
COLOR: RED	DRG CLASS: REV A	692N9V02	