









THE INFORMATION CONTAINED IN THIS DRAWING IS THE SOLE PROPERTY OF VTE INCORPORATED. ANY REPRODUCTION IN PART OR WHOLE WITHOUT THE WRITTEN PERMISSION OF VTE INCORPORATED IS PROHIBITED.

LTR.	REVISIONS	DATE	INT.
△	ADDED MATERIAL IDENTIFIER WILDCARD	05DEC08	BRH
Ⓑ	ADDED INSERT PART NUMBERS	16MAY13	BRH









Ⓐ

\* MATERIAL IDENTIFIER  
H=HALOGEN FREE  
V=95 DUROMETER PVC









STYLE "A" GRIP INSERTS Ⓑ

PART NUMBER	COLOR	CABLE C/L HEIGHT	STYLE "A"30		STYLE "A"50		STYLE "A"70		A30	A50	A70
			MIN.	MAX.	MIN.	MAX.	MIN.	MAX.			
729A30*02	RED	CABLE C/L HEIGHT	.36" / 9.1mm	.92" / 23.3mm	.59" / 14.9mm	.89" / 22.6mm	.64" / 16.3mm	.81" / 20.6mm			
729A30*14	BLACK	CABLE Ø	.300" / 7.6mm	.500" / 12.7mm	.700" / 17.8mm						
729A50*02	RED	MAX									
729A50*14	BLACK	TERMINAL Ø	1.13" / 28.8mm	1.13" / 28.8mm	1.13" / 28.8mm						
729A70*02	RED										
729A70*14	BLACK										

STYLE "B" GRIP INSERTS

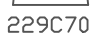
PART NUMBER	COLOR	CABLE C/L HEIGHT	STYLE "B"30		STYLE "B"50		STYLE "B"70		B30	B50	B70
			FIXED	FIXED	FIXED	FIXED	FIXED				
729B30*02	RED	CABLE C/L HEIGHT	.63" / 16.0mm	.63" / 16.0mm	.63" / 16.0mm						
729B30*14	BLACK	CABLE Ø	.300" / 7.6mm	.500" / 12.7mm	.700" / 17.8mm						
729B50*02	RED	MAX									
729B50*14	BLACK	TERMINAL Ø	1.13" / 28.8mm	1.13" / 28.8mm	1.13" / 28.8mm						
729B70*02	RED										
729B70*14	BLACK										

STYLE "C" GRIP INSERTS

PART NUMBER	COLOR	CABLE C/L HEIGHT	STYLE "C"30		STYLE "C"50		STYLE "C"70		C30	C50	C70
			FIXED	FIXED	FIXED	FIXED	FIXED				
729C30*02	RED	CABLE C/L HEIGHT	.63" / 16.0mm	.63" / 16.0mm	.63" / 16.0mm						
729C30*14	BLACK	CABLE Ø	.300" / 7.6mm	.500" / 12.7mm	.700" / 17.8mm						
729C50*02	RED	MAX									
729C50*14	BLACK	TERMINAL Ø	.60" / 15.2mm	.86" / 21.8mm	.98" / 24.9mm						
729C70*02	RED										
729C70*14	BLACK										

TOLERANCE UNLESS OTHERWISE SPECIFIED: ±.030"/±0.8mm  
RADIAL DIAMETERS TO BE MEASURED OVER MANDRELS,  
RING GAGES OR PIN GAGES OF SUITABLE SIZE

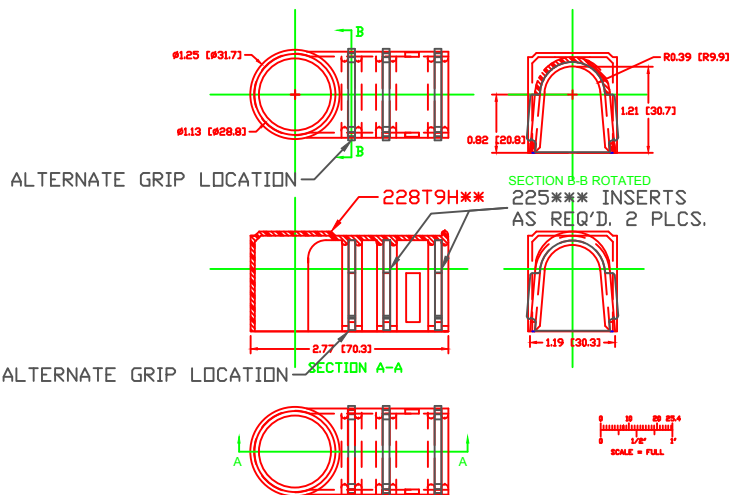

VTE Incorporated  
5437 Robinson Road, P.O. Box 790  
Pellston, Michigan 49769  
Telephone: 1-800-527-9256, 231-539-8000  
FAX: 231-539-0914

REF: 228T9 & 229***	DATE: 00-00-98	DRN BY: BRH	WEIGHT:
		CHK'D BY: BRH	
TITLE: TUNNEL CAP INSULATOR			SCALE:
MATERIAL:		PART NO.	
COLOR: CHARTED	DRG CLASS REV B	729 SERIES	