

THE INFORMATION CONTAINED IN THIS DRAWING IS THE SOLE PROPERTY OF VTE INCORPORATED. ANY REPRODUCTION IN PART OR WHOLE WITHOUT THE WRITTEN PERMISSION OF VTE INCORPORATED IS PROHIBITED. VTE MAKES NO WARRANTY, EXPRESSED OR IMPLIED, AS TO THE SUITABILITY OF A PRODUCT FOR ANY INTENDED USE. THE CUSTOMER SHALL BEAR THE SOLE RESPONSIBILITY OF DETERMINING THE SUITABILITY OF ANY VTE PRODUCT FOR ITS END USE.

LTR.	REVISIONS	DATE	INT.
⌒	UPDATED TORQUE VALUES FROM 180 IN-LBS [20.34 Nm]	2-03-18	RAS

USE GREENLEE PUNCH
ASSEMBLY #60098
FOR PANEL CUTOUT

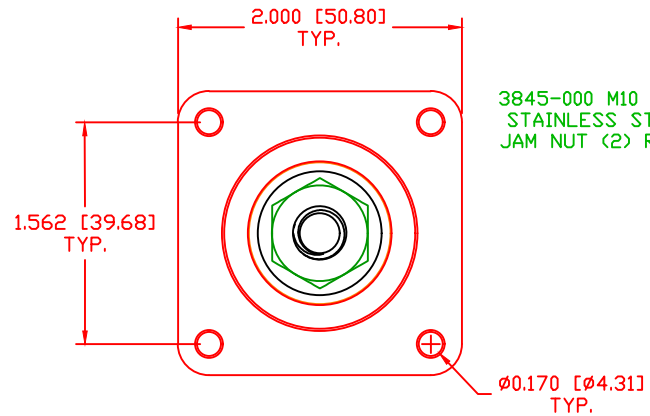
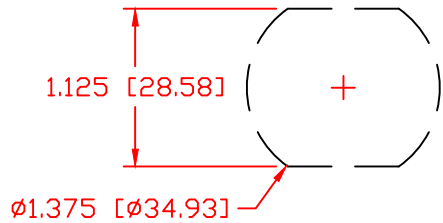

ASSEMBLY
CCFB106N02W
CONSIST OF :

- 1-CCFB106N02
POWER BUSHING
- 1-3960-002
SEALING GASKET
- 1-232N3V02
INSULATOR BOOT

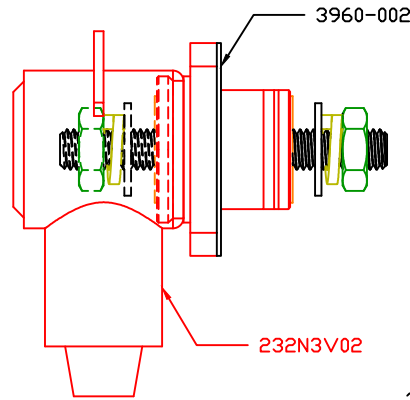

P/N 3960-002
.062 THICK CF 4480 81 DURDMETER
FIBERGLASS REINFORCED SILICONE
PRESS PAD SEALING GASKET

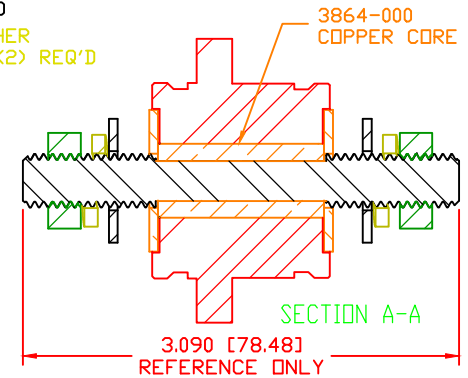
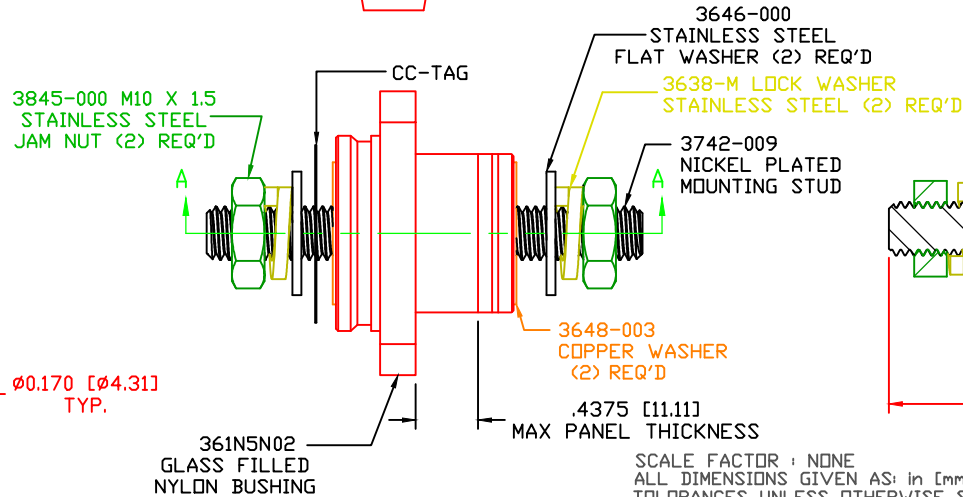
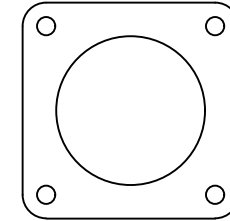

SCALE FACTOR : NONE
ALL DIMENSIONS GIVEN AS: in [mm]
TOLERANCES UNLESS OTHERWISE SPECIFIED :
MOLDED PARTS: ±.030" [±0.8mm]
HARDWARE ITEMS: ±.010" [±0.25mm]

⊕ MAXIMUM FASTENER TORQUES:
JAM NUTS: 212 IN-LBS [24.0 Nm]

CURRENT CARRYING CAPACITY:
DUTY CYCLE:
CURRENT CAPACITY:
TEMPORARY MAX (12 MINUTES)

80%
4.3 Kw (360 AMP @ 12VDC)
5.4 Kw (450 AMP @ 12VDC)

MATERIAL PART NO:
MATERIAL:
VENDOR PART NO:
SPECIFIC GRAVITY:
MELTING TEMP:
U.L. RATING:

7111210502
GLASS FILLED NYLON
NYLON N2015 HL NAT
1.23
515 F [268 C]
UL 94 HB

		VTE Incorporated 5437 Robinson Road, P.O. Box 790 Pellston, Michigan 49769 Telephone: 1-800-527-9256, 231-539-8000 FAX: 231-539-0914	
		REF: CUSTOMER DIMS	DATE: 11-16-17
TITLE: 10MM PANEL MOUNT POWER BUSHING, COPPER CORE		CHK'D BY: PJK	
MATERIAL: GLASS FILLED NYLON		PART NO. CCFB106N02W	
COLOR: RED	DRG CLASS: REV A		