

PROPRIETARY RIGHTS ARE CLAIMED FOR THE MATERIAL DISCLOSED IN THIS DRAWING.

TYP. WALL THICKNESS = 2.5

LTR.	REVISIONS	DATE
≠	*****	00-00-98

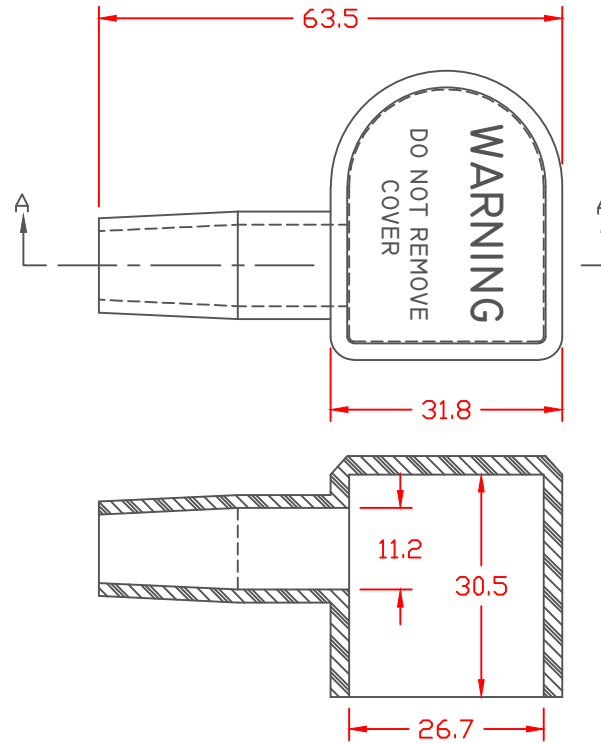
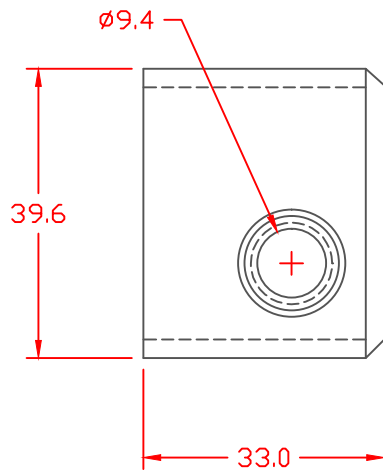

SECTION A-A

TOLERANCE UNLESS OTHERWISE SPECIFIED: ±0.30"/±0.8mm
 RADIAL DIAMETERS TO BE MEASURED OVER MANDRELS,
 RING GAGES OR PIN GAGES OF SUITABLE SIZE

VTE Material Part No:
 Material:
 Material Part No
 Max. Operating Temp:
 Shore Durometer
 Specific Gravity:
 Ult. Elongation %:
 Brittle Temp:
 Tensile Strength PSI:
 Dielectric Strength, v./ml
 U.L. Rating:
 MEETS:

1101650109
 BLUE PVC
 05-916R
 105 C
 "A" 65
 1.27
 325

 1500 PSI



VTE Incorporated
 5437 Robinson Road, P.O. Box 790
 Pellston, Michigan 49769
 Telephone: 1-800-527-9256, 231-539-8000
 FAX: 231-539-0914

REF:	DATE: 3-30-98	DRN BY: CJC	WEIGHT: 04 LBS. / 18.3 G.
TITLE: U-1 BATTERY TERMINAL BOOT			
MATERIAL:		PART NO. 444L8V09	
COLOR:	DRG CLASS		