

THE INFORMATION CONTAINED IN THIS DRAWING IS THE SOLE PROPERTY OF VTE INCORPORATED. ANY REPRODUCTION IN PART OR WHOLE WITHOUT THE WRITTEN PERMISSION OF VTE INCORPORATED IS PROHIBITED.

LTR.	REVISIONS	DATE
≠	*****	00-00-98

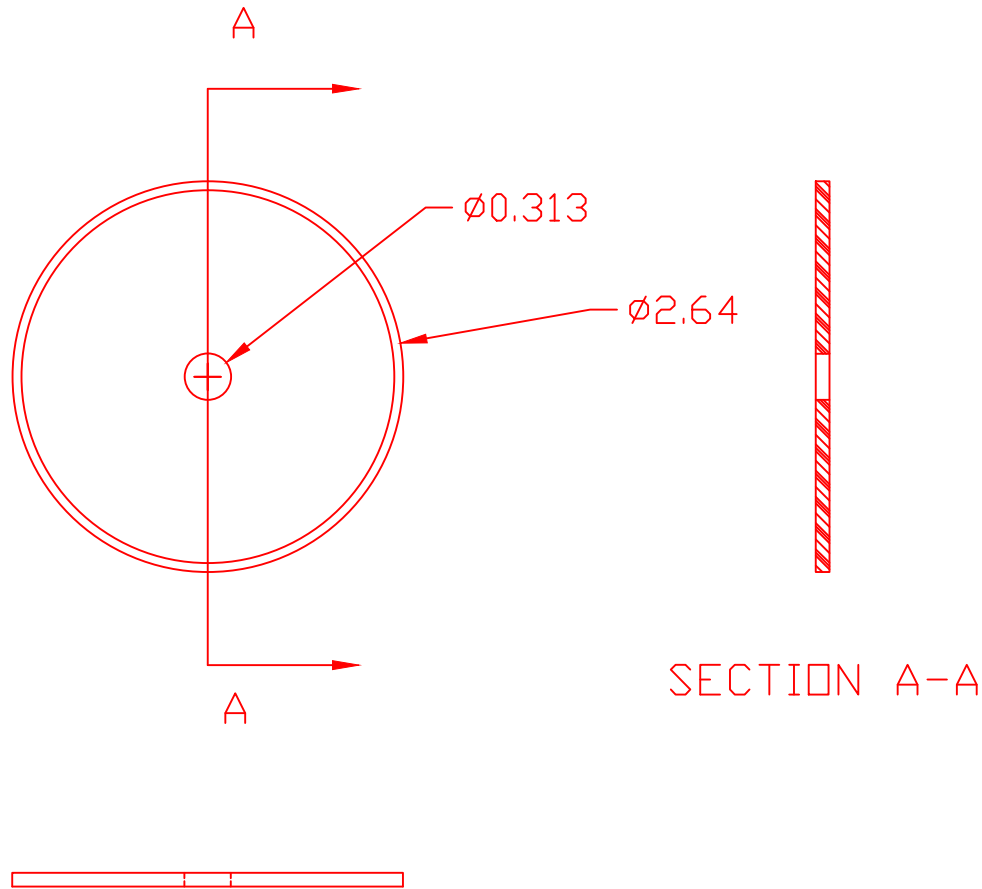

Material:	Polypropylene
Material Part No	7209750302
Max. Operating Temp:	550 F
Durometer:	110 R-Scale
Specific Gravity:	1.13
Ult. Elongation %:	2.5
Modulus PSI:	Not Tested
Tensile Strength PSI:	9500
Dielectric Strength, v./ml	Not Tested
MEETS:	UL94HB



VTE Incorporated
 5437 Robinson Road, P.O. Box 790
 Pellston, Michigan 49769
 Telephone: 1-800-527-9256, 231-539-8000
 FAX: 231-539-0914

REF:	DATE:	DRN BY:	BRH	WEIGHT:
479N0P02	31-MAY-01	CHK'D BY:	BRH	***
TITLE: POWER POLE+ INSULATOR 5/16"				SCALE: NOTED
MATERIAL: NOTED			PART NO.	
COLOR: RED			47931 P02	
DRG CLASS			***	

