

PROPRIETARY RIGHTS ARE CLAIMED FOR THE MATERIAL DISCLOSED IN THIS DRAWING.

TYP. WALL THICKNESS = 2.5

LTR.	REVISIONS	DATE
≠	*****	00-00-98

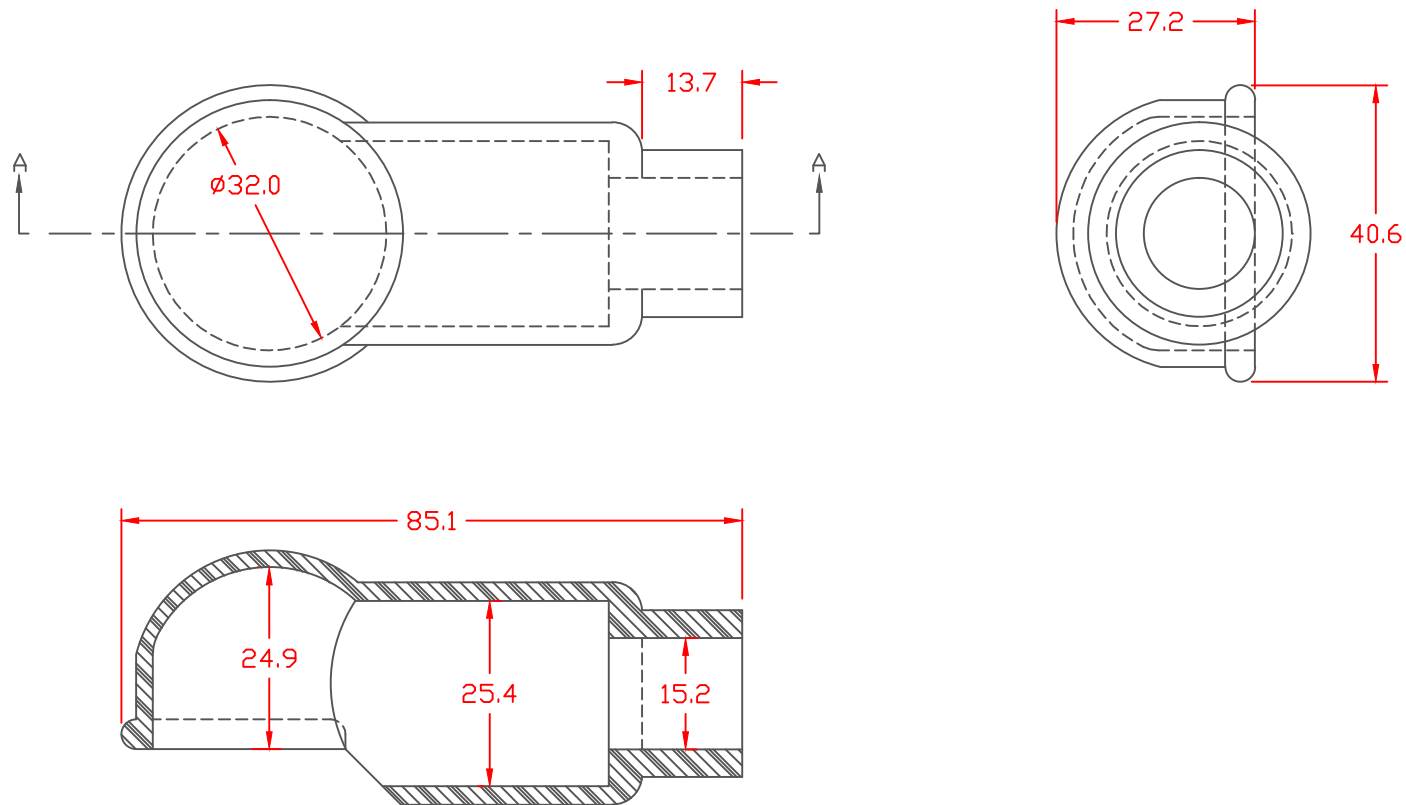

TOLERANCE UNLESS OTHERWISE SPECIFIED: ±.030"/±0.8mm
 RADIAL DIAMETERS TO BE MEASURED OVER MANDRELS,
 RING GAGES OR PIN GAGES OF SUITABLE SIZE

SECTION A-A

VTE Material Part No:	1101700114
Material:	BLACK PVC
Material Part No	M1170-FR or Equivalent
Max. Operating Temp:	105 C
Shore Durometer	"A" 15 SEC. 70+/-5
Specific Gravity:	1.34
Ult. Elongation %:	275 Minimum
Tensile Strength PSI:	1600 PSI Minimum
U.L. Rating:	94 V0



		VTE Incorporated 5437 Robinson Road, P.O. Box 790 Pellston, Michigan 49769 Telephone: 1-800-527-9256, 231-539-8000 FAX: 231-539-0914	
		REF:	DATE:
	4-6-98	CHK'D BY:	058 LBS. / 26.4 G.
TITLE: STARTER EYELET TERMINAL INSULATOR			
MATERIAL:		PART NO.	
		487N7F14	
COLOR:	DRG CLASS		