

THE INFORMATION CONTAINED IN THIS DRAWING IS THE SOLE PROPERTY OF VTE INCORPORATED. ANY REPRODUCTION IN PART OR WHOLE WITHOUT THE WRITTEN PERMISSION OF VTE INCORPORATED IS PROHIBITED.

LTR.	REVISIONS	DATE
≠	*****	00-000-00

P/N 360N8N02 BUSHING

ITEM NUMBER: 7376M

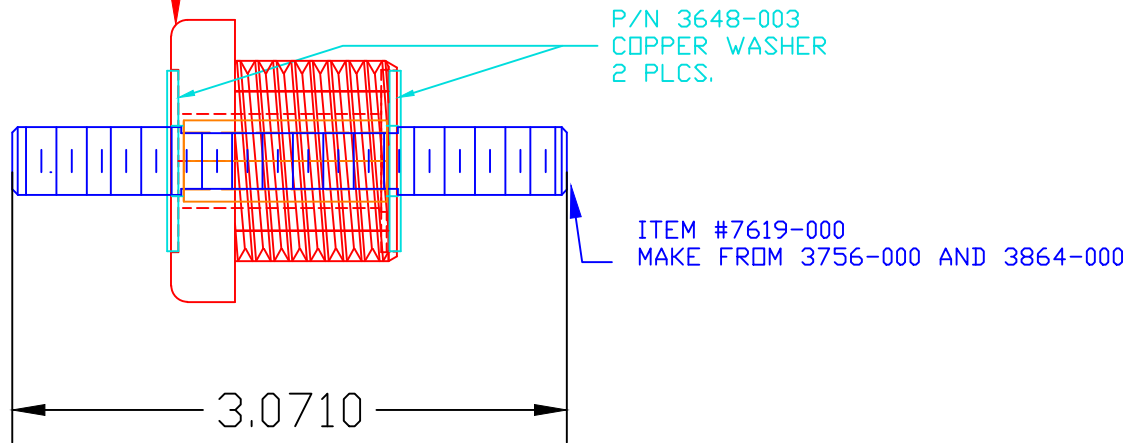

TOLERANCE UNLESS OTHERWISE SPECIFIED:
 MOLDED PRODUCTS ONLY: $\pm 0.30^\circ / \pm 0.8\text{mm}$
 HARDWARE ITEMS: $\pm 0.010^\circ / \pm 0.25\text{mm}$
 RADIAL DIAMETERS TO BE MEASURED OVER MANDRELS,
 RING GAGES OR PIN GAGES OF SUITABLE SIZE



VTE Incorporated
 5437 Robinson Road, P.O. Box 790
 Pellston, Michigan 49769
 Telephone: 1-800-527-9256, 231-539-8000
 FAX: 231-539-0914

REF: *****	DATE: 27MAY10	DRN BY: BRH	WEIGHT: *****
TITLE: POWER BUSHING, COPPER M10			SCALE:
MATERIAL:		PART NO.	
COLOR: *****	DRG CLASS *****	7376M02	